

Technical Information 0357 28D XX

- Use only Chain KMC S1 (former Z410)
- no chain locks, only rivet the chain
- optimal chain sag 12,8mm
- inner parts needs horizontal clearance of 1-2mm
- check moveability after mounting the rear & front part!

Assembly:

1. insert complete upper/lower guiding rail into the clips
2. insert guiding rail of rear part into the clips
3. pull front and rear part apart
4. click front and rear part together

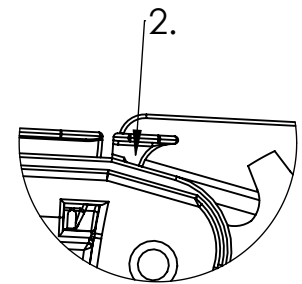

DETAIL A

MABSTAB 1 : 1

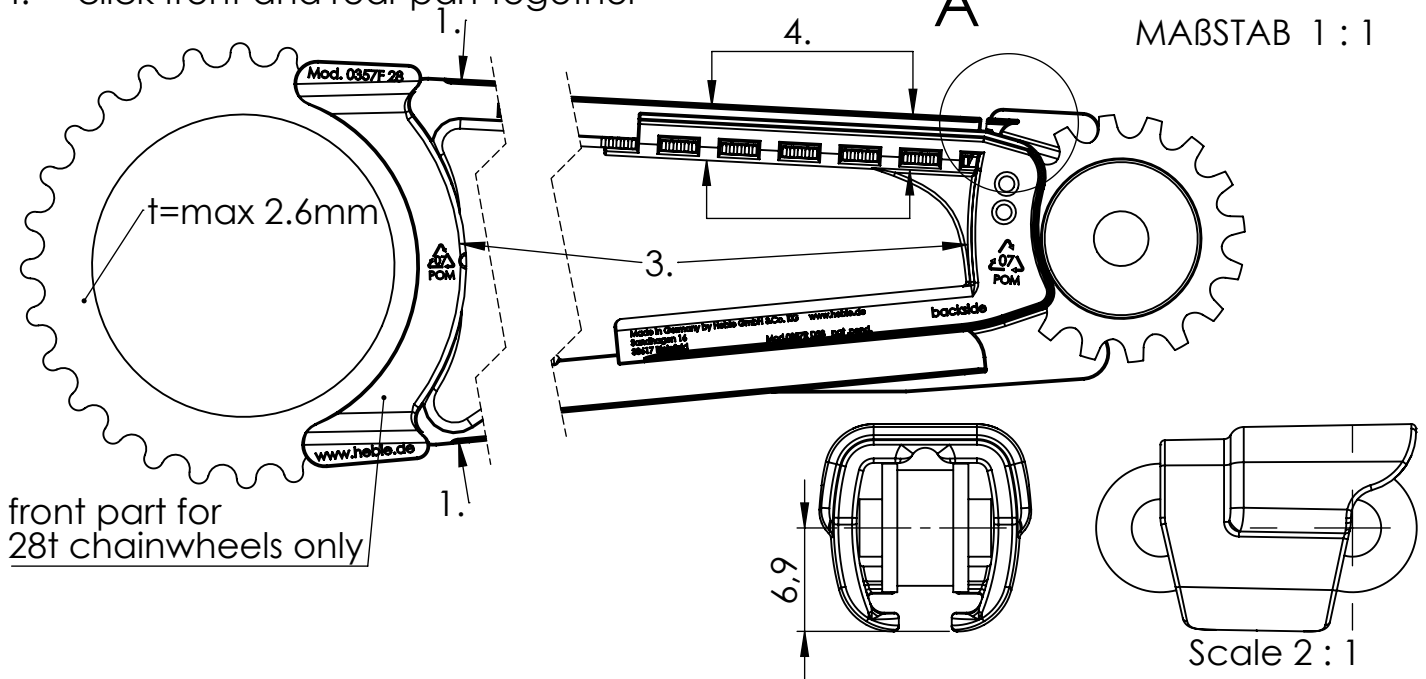

Approved configurations*

No.	Supplier	Code-No.	parts name	Description		RC** min/max ->	chain links min/max
1	SUNRACE/Sturmey Archer	SFX30	Freewheel	15T 1/2x3/32		306/357	70/78
2	RUBY	SFW-17T	Freewheel	17T, 1/2x3/32		326/351	74/78
3	RUBY	SFW-18T	Freewheel	18T, 1/2x3/32		348/361	78/80
4	LIDA	LMA-0/AON-15	Freewheel	15T, 1/2x3/32 @30mm		306/357	70/78
5	LIDA	LMA-8	Freewheel	17T, 1/2x3/32 @1.37"		326/364	74/80
6	SHIMANO	KCBE110AXM	Rearhub	Coaster, 1-sp.	see sprocket pos. 8-9		
7	SHIMANO	SG-3R40, SG-3RC41, SG-3D55	Rearhub	NEXUS-3	see sprocket pos. 8-9		
8	SHIMANO	ASMGEAR16LP	Sprocket	16T, 2,3mm	dished	303/354	70/78
9	SHIMANO	ASMGEAR18LP	Sprocket	18T, 2,3mm	dished	348/361	78/80
10	KT	KT-307/KT-A13R	Rearhub	Coaster, 1-sp.	see sprocket pos.11 - 12		
11	KT	14T	Sprocket	14T, 2,3mm	dished	297/348	68/76
12	KT	16T	Sprocket	16T, 2,3mm	dished	303/354	70/78
13	FALCON	CF-E12	Rearhub	Coaster, 1-sp.	see sprocket pos.14 - 15		
14	FALCON	16T	Sprocket	16T, 2,3mm	dished	303/354	70/78
15	FALCON	18T	Sprocket	18T, 2,3mm	dished	348/361	78/80
16	SUNRACE Sturmey Archer	CBS1C	Rearhub	Coaster, 1-sp.	see sprocket pos.18 - 20		
17		IHS3S AWC	Rearhub	3-sp.	see sprocket pos.18 - 20		
18		16T	Sprocket	16T, 1/2x3/32	CSISN Dished	303/354	70/78
19		17T	Sprocket	17T, 1/2x3/32	CSISN Dished	326/364	74/80
20		18T	Sprocket	18/T, 1/2x3/32	CSISN Dished	348/361	78/80

*Hebie offers test service for OEM for not listed parts and configurations

**w/o sag